

BILL OF MATERIAL (CURRENT LEVEL)				
ITEM	PT/ASSY	DESCRIPTION	TYPE	QTY.
1	672	DECORATIVE RING	PART	3
2	1995	MOUNTING FLANGE	PART	3
3	5087	48" GRAB BAR, ADAPTER AND POST ASSY	ASSEMBLY	1
4	199X	GRAB BAR HARDWARE PACK	ASSEMBLY	3

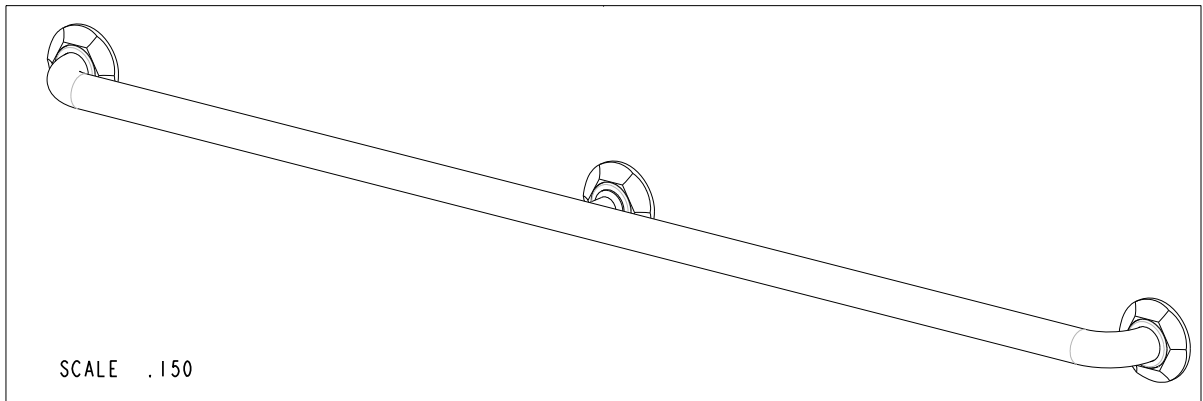
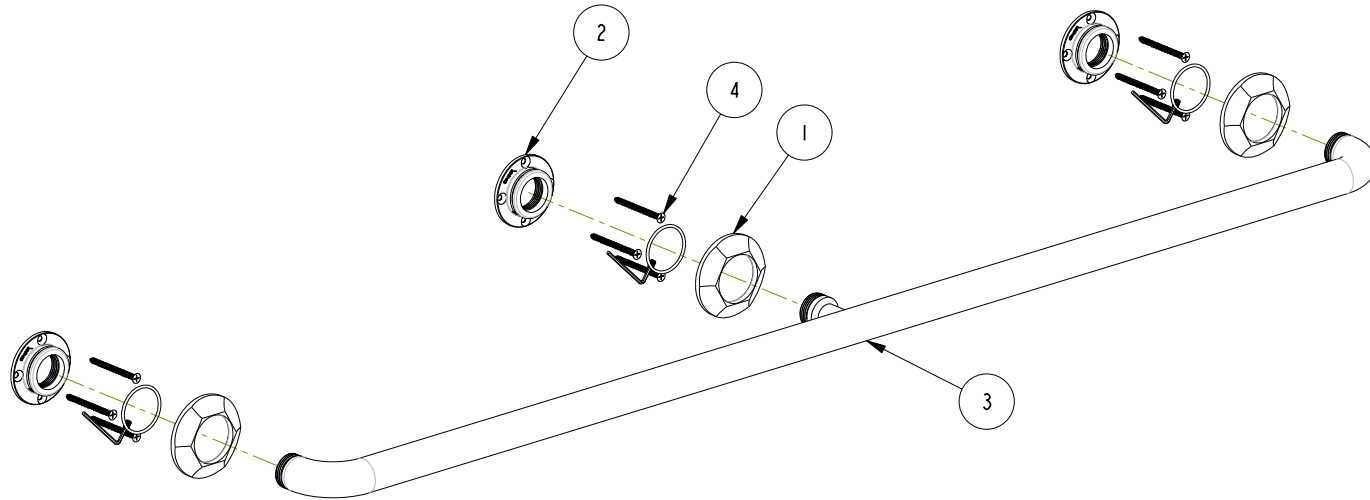

COPYRIGHT 2005 GINGER. THESE DRAWINGS AND THE DESIGNS DEPICTED HEREIN ARE THE PROPRIETARY PROPERTY OF GINGER. ANY USE OR REPRODUCTION IS SUBJECT TO THE EXPRESS APPROVAL OF GINGER. UNAUTHORIZED USE IS STRICTLY PROHIBITED. ALL RIGHTS RESERVED.

GINGER

2001 E. CARNEGIE AVE.
SANTA ANNA CA 92705
(949) 417-5207

48" STRAIGHT GRAB BAR ASSEMBLY

ASSY. NO. 667

SCALE .150

REF. -

SHEET 1 OF 2

A

EN-1009

11/20/09

REV

REV DESC

DATE

SPECIFICATION DWG

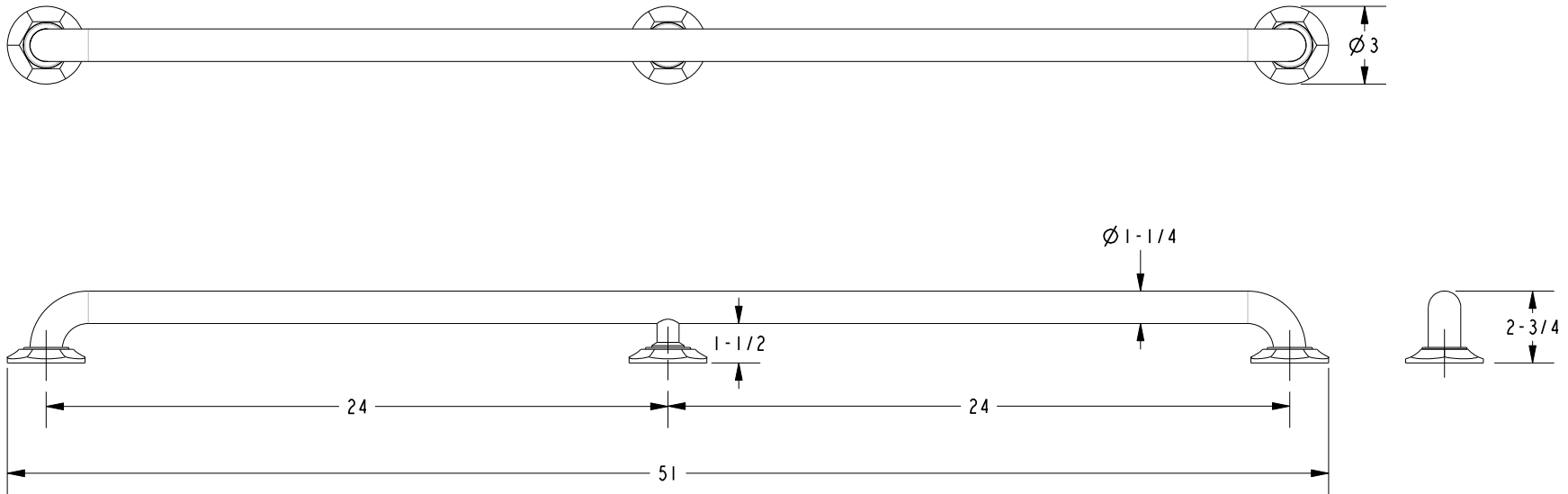

 MEETS OR EXCEEDS ASTM F446 STANDARDS AND CONFORMS TO ADA GUIDELINES.

DIMENSIONS ARE IN INCHES AND AN APPROXIMATION OF A TYPICAL INSTALLATION

COPYRIGHT 2005 GINGER. THESE DRAWINGS AND THE DESIGNS DEPICTED HEREIN ARE THE PROPRIETARY PROPERTY OF GINGER. ANY USE OR REPRODUCTION IS SUBJECT TO THE EXPRESS APPROVAL OF GINGER. UNAUTHORIZED USE IS STRICTLY PROHIBITED. ALL RIGHTS RESERVED.

GINGER		2001 E. CARNEGIE AVE. SANTA ANNA CA 92705 (949) 417-5207	
DWG NO.	667	REV	A
SCALE	.150	REF.	-
		SHEET	2 OF 2